

30" VENTED
GAS LOG
MODEL: GLDF30M-V



Thermablaster®

BY *Reecon*



CAUTION - FOR YOUR SAFETY

⚠ WARNING: IF THE INFORMATION IN THIS MANUAL IS NOT FOLLOWED EXACTLY, A FIRE OR EXPLOSION MAY RESULT CAUSING PROPERTY DAMAGE, PERSONAL INJURY, OR LOSS OF LIFE.

- Do not store or use gasoline or other flammable vapors and liquid in vicinity of this or any other appliance.

WHAT TO DO IF YOU SMELL GAS

- Do not try to light any appliance
 - Do not touch any electrical switch; do not use any phone in your building.
 - Immediately call your gas supplier from a neighbor's phone. Follow the gas supplier's instructions.
 - If you cannot reach your gas supplier, call the fire department.
- Installation and service must be performed by a qualified installer, service agency or the gas supplier.

INSTALLER: Leave this manual with the appliance.

CONSUMER: Retain this manual for future reference.

This is an unvented gas-fired heater. It uses air (oxygen) from the room in which it is installed. Provisions for adequate combustion and ventilation air must be provided. Refer to Air for Combustion and Ventilation section on page 8 of this manual. Warranty is void if not professionally installed.

This appliance may be installed in an aftermarket, permanently located, manufactured (mobile) home, where not prohibited by local codes. This appliance is only for use with propane or natural gas. This appliance is equipped with a simple means to switch between propane and natural gas in dual fuel models only. Field conversion by any other means including the use of a kit is not permitted.

⚠ WARNING: Do not attempt to access or change the setting of the fuel selection means. Access to and adjustment of the fuel selection means must only be performed by a qualified service person when connecting this appliance to a specified fuel supply at the time of installation. Change of the selector setting to other than the fuel type specified at the time of installation could damage this appliance and render it inoperable. The installer shall replace the access cover before completing the installation and operating this appliance.



Questions, problems? Before returning to your retailer, call our customer service department at 1-877-670-8428, 9:00 am - 6:00 pm EST, Monday through Friday or email service@thermablaster.com



Conforms to ANS Z21.60-2012. Gas-Fired Room Heater Volume II, Vented Room Heater

TABLE OF CONTENTS

About Us.....1	Installation Considerations.....11
Product Specifications.....1	Connecting to Gas Supply.....17
Important Safety Information.....2	Unit Operation.....19
Product Features.....4	Care and Maintenance.....22
Installation Checklist.....5	Troubleshooting.....23
Water Vapor.....7	Illustrated Parts and Parts List.....27
Air for Combustion.....8	Service Schedule, Registration and Contact Information.....28
Determining Fresh Air Flow.....9	

ABOUT US

We at Reecon strive to produce the highest quality Thermablaster heaters to warm our customers. We feel that a heater should look as good as it operates and work without a fuss. That is why we have developed our patent pending dual fuel heating system, which allows the use of either liquid propane or natural gas for some of our most popular products, without requiring any adjustments. Our product lines consist of vent free gas wall heaters, a direct vent gas wall heater line, kerosene and propane forced air heaters, electric industrial heaters, fireplace sets, as well as outdoor heating products. Through our innovative product design and customer first mentality, we strive to provide the best heaters for all needs, at a price that won't break the bank.

PRODUCT SPECIFICATIONS

Model	GLDF30M-V
Gas type	Using natural gas
Nominal Heat Input	48,000 Btu/hr
Minimum Inlet Supply Pressure (W.C.)	6"
Maximum Inlet Supply Pressure (W.C.)	9"
Manifold Pressure (W.C.)	5.2"
Nominal Input Pressure (W.C.)	7"
Gas type	Using propane gas
Nominal Heat Input	48,000 Btu/hr
Minimum Inlet Supply Pressure (W.C.)	8"
Maximum Inlet Supply Pressure (W.C.)	14"
Manifold Pressure (W.C.)	6"
Nominal Input Pressure (W.C.)	11"
Ignition	Electric Pulse
Package Dimension (H×W×D)	16.93"x32.87"x17.32"
Heater Dimension (H×W×D)	15.7"x30"x12"

IMPORTANT SAFETY INFORMATION

 **IMPORTANT:** Read this owner's manual carefully and completely before trying to assemble, operate, or service this heater. Improper use of this heater can cause serious injury or death from burns, fire, explosion, electrical shock, and carbon monoxide poisoning. Only a qualified installer, service agent, or local gas supplier may install and service this product.

 **WARNING:** Do not store or use gasoline or other flammable vapors and liquids in the vicinity of this or any other appliance.

CARBON MONOXIDE POISONING: Early signs of carbon monoxide poisoning resemble the flu with headache, dizziness and/or nausea. If you have these signs, heater may not be working properly. Get fresh air at once! Have heater serviced. Some people - pregnant women, persons with heart or lung disease, anemia, those under the influence of alcohol, those at high altitude - are more affected by carbon monoxide than others.

Natural and Propane /LP Gas: Natural and Propane/LP gas are odorless. An odor-producing agent is added to the gas. The odor helps you detect a gas leak. However, the odor added to the gas can fade. Gas may be present even though no odor exists.

 **WARNING:** Any change to this heater or its controls can be dangerous.

 **WARNING:** Do not use any accessories not approved for use with this heater.

 **WARNING:** Carefully supervise young children when they are in the room with the heater.

 **WARNING:** Make sure grill guard is in place before running heater.

 **WARNING:** Keep the appliance area clear and free from combustible materials, gasoline, and other flammable vapors and liquids.

 **WARNING:** Due to high temperatures, the appliance should be located out of traffic and away from furniture and draperies.

 **WARNING:** Heater becomes very hot when running. Keep children and adults away from hot surfaces to avoid burns or clothing ignition. Heater will remain hot for a time after shutoff. Allow surfaces to cool before touching.

 **WARNING:** Do not place clothing or other flammable material on or near the appliance. Never place any objects in the heater.

 **WARNING:** Failure to keep the primary air opening(s) of the burner(s) clean may result in sooting and property damage.

 **WARNING:** Do not allow fans to blow directly towards the heater. Avoid any drafts that alter burner flame patterns.

 **WARNING:** Do not use a blower insert, heat exchanger insert or other accessory not approved for use with this heater.

 **WARNING:** Failure to position the parts in accordance with these diagrams or failure to use only parts specifically approve with this heater may result in property damage or personal injury.

CAUTION: Two gas line installations at the same time are prohibited. The ignition button on the dual fuel models shall not be depressed while the heater is in operation.

1. Installation and provisions for combustion and ventilation air must conform with the *National Fuel Gas Code*, ANSI Z223.1/NFPA 54, or the *Natural Gas and Propane Installation Code*, CSA B149.1.

2. Do not place Propane/LP supply tank(s) inside any structure. Propane/LP supply tank(s) must be placed outdoors.

3. This heater shall not be installed in the place

which the strong wind would shut down the appliance.

4. This heater needs fresh air ventilation to run properly. This heater has an Oxygen Depletion Sensing (ODS) safety shutoff system. The ODS shuts down the heater if not enough fresh air is available. See Air for Combustion and Ventilation, page 7. If heater keeps shutting off, see troubleshooting.

5. Keep all air openings in front and bottom of heater clear and free of debris. This will ensure enough air for proper combustion.

6. If heater shuts off, do not relight until you have provided fresh air from outside. If heater keeps shutting off, have it serviced.

7. Do not run heater where flammable liquids or vapors are used or stored under dusty conditions.

8. Before using furniture polish, wax, carpet cleaner, or similar products, turn heater off. If heated, the vapors from these products may create a white powder residue within burner box or on adjacent walls or furniture.

9. Never set control knob between locked positions, otherwise poor combustion and higher levels of carbon monoxide may be resulted.

10. "Do not use this room heater if any part has been under water. Immediately call a qualified service technician to inspect the room heater and to replace any part of the control system and any gas control which has been under water."

11. Turn off and let heater cool down before servicing. Only a qualified service person should service and repair heater.

12. Periodic visual check of pilot and burner flame, with pictorial sketches or drawings.

13. The appliance must be isolated from the gas supply piping system by closing its equipment shut-off valve during any pressure testing of the

gas supply piping system at test pressures equal to or less than 1/2 psi (3.5 kPa).

14. This appliance must be installed only in a solid-fuel burning fireplace with a working flue and constructed of noncombustible material.

15. Solid fuels shall not be burned in a fireplace where a decorative appliance is installed.

16. A fireplace screen must be in place when the appliance is operating and unless other provisions for combustion air are provided, the screen shall have an opening(s) for introduction of combustion air.

17. The installation of appliances designed for manufactured home (U.S. only) or mobile home installation must conform with the *Standard for Mobile Housing, CAN/CSA Z240 MH*, in Canada, or with the *Manufactured Home Construction and Safety Standard, Title 24 CFR, Part 3280*, in the United States, or when such a standard is not applicable, *Manufactured Home Installations Standard, ANSI/NCSBCS A225.1/NFPA 501A*.

18. Logs are fragile; handle with care.

19. A damper clamp must be installed to provide minimum permanent vent opening to vent flue products, Refer to installation instructions.

Important Note:

- An unvented room heater having an input rating of more than 10,000 Btu/hr (2,931 W) shall not be installed in a bedroom or bathroom; or
- An unvented room heater having an input rating of more than 6000 Btu/hr (1,758 W) shall not be installed in a bathroom.

 **WARNING:** This products contains chemicals, including lead and lead compounds, known to the State of California to cause(cancer,and) birth defects or other reproductive harm. Wash your

hands after handling this products.

 **WARNING:** Combustion by-products produced when using this product contain carbon monoxide, a chemical known to the State of California to cause birth defects (or other reproductive harm known to cause cancer)

QUALIFIED INSTALLING AGENCY

Only a qualified agency should install and replace gas piping, gas utilization equipment or accessories, repair and service the heater. The term “qualified agency” means any individual, firm, corporation, or company that either in person or through a representative is engaged in and is responsible for:

- a) Installing, testing, or replacing gas piping or
- b) Connecting, installing, testing, repairing, or servicing equipment; that is experienced in such work; that is familiar with all precautions required; and that has complied with all the requirements of the authority having jurisdiction.

PRODUCT FEATURES

SAFETY PILOT

This heater has a pilot with an Oxygen Depletion Sensing (ODS) safety shutoff system. The ODS/pilot shuts off the heater if there is not enough fresh air.

PULSE IGNITION SYSTEM

This heater is equipped with a battery powered electric pulse igniting system. No AC power supply required. Battery should be periodically checked and replaced accordingly. Use “AA” size 1.5 V battery only.

GAS OPTIONS CAPABLE (Dual Fuel Models Only) (Models that start with GLDF)

If you have the dual fuel model, your heater is equipped to operate on either propane or natural gas. The heater will automatically identify your gas source without any manual changes.

LOCAL CODES

Install and use heater with care. Follow all local codes. In the absence of local codes, use the latest edition of The National Fuel Gas Code, ANSI Z223.1/ NFPA 54.

INSTALLATION CHECKLIST

Share this checklist with your professional installer

Manifold Pressure and Nominal Inlet Pressure for appropriate gas type

- Using Natural Gas:
 - Minimum Inlet Pressure (W.C.): 6"
 - Manifold Pressure (W.C.): 5.2"
 - Nominal Input Pressure (W.C.): 7"
- Using Propane Gas:
 - Minimum Inlet Pressure (W.C.): 8"
 - Manifold Pressure (W.C.): 6"
 - Nominal Input Pressure (W.C.): 11"

Clearances

- 5" minimum from bottom of heater to Top Surface of Floor
- 16" Minimum from sides to of Heater
- 42" Minimum clearance from top surface of heater and up

Connected to gas supply using a 5/8th inch UNF inlet connection to a 1/2 inch gas pipe

Unit is placed in a room that is a minimum of 1,200 square feet.

AA battery installed

Adequate ventilation and fresh-air flow is appropriate for heater location

The Air Shutter is pre-set for Liquid Propane use. If using Natural Gas, see Air Shutter section of manual.

Unit successfully tested

- Installed by:
 - Company _____
 - Installer _____
 - Contact Info _____
 - Date _____

Note to installer: Ensure that you are referencing the product manual for full details on each of the installation steps, warnings and considerations. This list is to be used to confirm the steps as you move through the installation. Please leave this sheet with the user.

*Do not attempt any modifications, repairs or replacements on this unit without first discussing with Thermablaster Technical Support. Doing so will void the product's warranty. Professional Installation is required by all local and National codes.

Unit is not to be used as a central heating system

Preparing for Installation

Before beginning assembly or operation of the product, make sure all parts are present. Compare parts with package contents list and diagram above. If any part is missing or damaged, do not attempt to assemble, install or operate the product. Contact customer service for replacement parts.

Before installing heater, make sure you have the items listed below:



Figure 1 - Vented Gas log

UNPACKING

1. Remove heater from carton.
2. Remove all protective packaging applied to heater for shipping.
3. Check heater for any shipping damage. If heater is damaged, promptly inform dealer where you purchased heater.
4. Remove thread protective cup on the gas inlet pipe underneath the heater.
5. Install 2 AA batteries. Be sure batteries has full capacity. Batteries must be removed if the heater is not in use for an extended period of time.

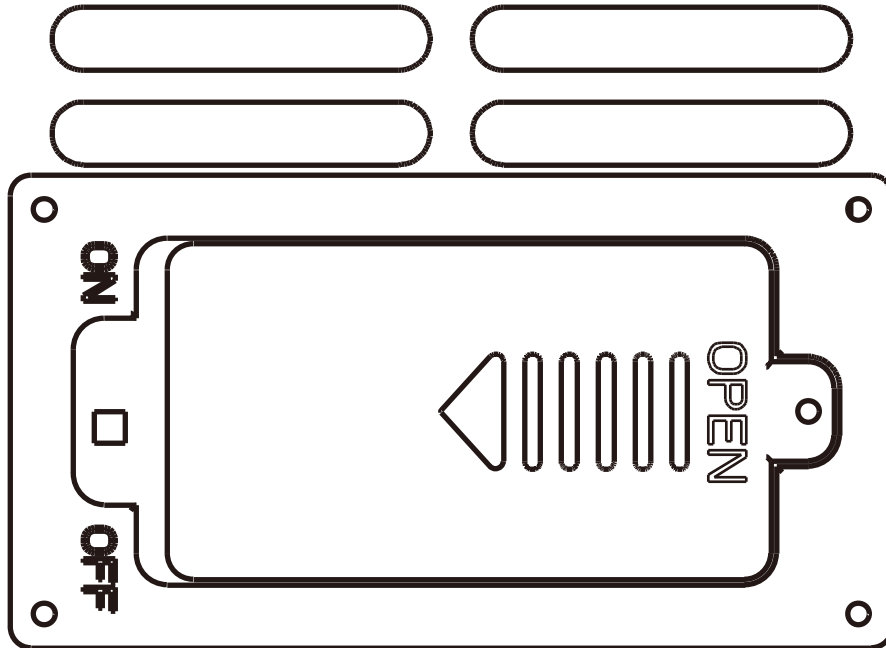



Figure 2 – Battery Cover and Power Switch

WATER VAPOR: A BY-PRODUCT OF UNVENTED ROOM HEATERS

Water vapor is a by-product of gas combustion. An unvented room heater produces approximately one (1) ounce (30 ml) of water for every 1,000 BTUs (0.3 KWs) of gas input per hour. Unvented room heaters are recommended as supplemental heat (a room) rather than a primary heat source (an entire house). In most supplemental heat applications, the water vapor does not create a problem. In most applications, the water vapor enhances the low humidity atmosphere experienced during cold weather. The following steps will help ensure that water vapor does not become a problem:

1. Be sure the heater is sized properly for the application, including ample combustion air and circulation air.
2. If high humidity is experienced, a dehumidifier may be used to help lower the water vapor content of the air.
3. Do not use an unvented room heater as the primary heat source.

AIR FOR COMBUSTION AND VENTILATION

 **WARNING:** This heater shall not be installed in a confined space or unusually tight construction unless provisions are provided for adequate combustion and ventilation air. Read the following instructions to ensure proper fresh air for this and other fuel-burning appliances in your home.

Providing Adequate Ventilation

This heater shall not be installed in a room or space unless the required volume of indoor combustion air is provided by the method described in the NATIONAL FUEL GAS CODE, ANSI Z223.1/NFPA 54, the INTERNATIONAL FUEL GAS CODE, or applicable local codes. The following are excerpts from National Fuel Gas Code, ANSI Z223.1/ NFPA 54. Air for Combustion and Ventilation. All spaces in homes fall into one of the three following ventilation classifications:

1. Unusually Tight Construction
2. Unconfined Space
3. Confined Space

The information on the following pages will help you classify your space and provide adequate ventilation.

Confined and Unconfined Space

The National Fuel Gas Code, ANSI Z223.1/NFPA 54 defines a confined space as a space whose volume is less than 50 cu. ft. per 1,000 BTU/hr (4.8 m³ per kw) of the aggregate input rating of all appliances installed in that space and an unconfined space as a space whose volume is not less than 50 cubic feet per 1,000 BTU/hr (4.8 m³ per kw) of the aggregate input rating of all appliances installed in that space. Rooms connecting directly with the space in which the appliances are installed, through openings not furnished with doors, are considered a part of the unconfined space. This heater shall not be installed in a confined

space or unusually tight construction unless provisions are provided for adequate combustion and ventilation air. Adjoining rooms are connecting only if there are odorless passageways or ventilation grills between them.

Unusually Tight Construction

The air that leaks around doors and windows may provide enough fresh air for combustion and ventilation. However, in buildings of unusually tight construction, you must provide additional fresh air. Unusually tight construction is defined as construction where:

- a) Walls and ceilings exposed to the outside atmosphere have a continuous water vapor retarder with a rating of one perm (6×10⁻¹¹kg per pa-sec-m²) or less with openings gasket or sealed and
- b) Weather stripping has been added on openable windows and on doors and
- c) Caulking or sealants are applied to areas such as joints around window and door frames, between sole plates and floors, between wall ceiling joints, between wall panels, at penetrations for plumbing, electrical, and gas lines, and at other openings.

If your home meets all of the three criteria above, you must provide additional fresh air. See “Ventilation Air from Outdoors”. If your home does not meet all of the three criteria above, proceed to “Determining Fresh-Air Flow for Heater Location”.

DETERMINING FRESH-AIR FLOW FOR HEATER LOCATION

Use this worksheet to determine if you have a confined or unconfined space. Space: Includes the room in which you will install heater plus any adjoining rooms with door less passageways or ventilation grills between the rooms.

1. Determine the Volume of space in cubic feet

Length X Width X Height = _____ cu. Ft.
(Including adjoining rooms with door less passageways or ventilation grills between rooms)

Example: 24' (L) X 16' (W) 8' (H) = 3,072 cu. Ft.

2. Multiply the volume of space by 20 BTU/Hr. to determine the maximum BTU/Hr. the space can support.

Example: 3.072 cu. Ft. X 20 BTU/Hr. = 61,440 BTU/Hr.
(Maximum BTU/Hr. the room can support)

3. Add the BTU/Hr. of all the fuel burning appliances in the space

Vent Free Heater _____ BTU/Hr.
Gas Appliance #1 _____ BTU/Hr.
Gas Appliance #2 _____ BTU/Hr.

Example: Vent Free Heater 26,000 BTU/Hr.
 Gas Appliance #1 35,000 BTU/Hr.
 Total 61,000 BTU/Hr.

The space in the prior example is a confined space because the actual BTU/hr used is more than the maximum BTU/hr the space can support.

You must provide additional fresh air. Your options are as follows:

Rework worksheet, adding the space of an adjoining room. If the extra space provides an unconfined space:

- a) Remove door to adjoining room or add ventilation grills between rooms. See "Ventilation Air from Inside Building" on next page.
- b) Vent room directly to the outdoors. See the following "Ventilation Air from Outdoors" for details.
- c) Install a lower BTU/hr heater if lower BTU/hr size makes room unconfined. If the actual BTU/hr used is less than the maximum BTU/hr the space can support, the space is an unconfined space. You will need no additional fresh air ventilation.

 **WARNING:** If the area in which the heater may be operated is smaller than that defined as an unconfined space, or if the building is of unusually tight construction, provide adequate combustion and ventilation air by one of the methods described in the National Fuel Gas Code, ANSI Z223.1/NFPA 54, Air for Combustion and Ventilation, or applicable local codes.

⚠ WARNING: If the area in which the heater may be operated does not meet the required volume for indoor combustion air, combustion and ventilation air shall be provided by one of the methods described in the *National Fuel Gas Code*, ANSI Z223.1/NFPA 54, the *International Fuel Gas Code*, or applicable local codes.

Ventilation Air from Inside Building

This fresh air would come from an adjoining unconfined space. When ventilating to an adjoining unconfined space, you must provide two permanent openings: one within 12 inches of the ceiling and one within 12 inches of the floor on the wall connecting the two spaces (Figure 3). You can also remove the door into adjoining room (see option 3, Figure 3). Follow the National Fuel Gas Code, ANSI Z223.1/NFPA 54, Air for Combustion and Ventilation for required size of ventilation grills or ducts.

Ventilation Air from Outdoors

Provide extra fresh air by using ventilation grills or ducts. You must provide two permanent openings: one within 12 inches of the ceiling and one within 12 inches of the floor. Connect these items directly to the outdoors or spaces open to the outdoors. These spaces include attics and crawl spaces. Follow the National Fuel Gas Code, ANSI Z223.1/ NFPA 54, Air for Combustion and Ventilation for required size of ventilation grills or ducts.

⚠ IMPORTANT: Do not provide openings for inlet or outlet air into attic if attic has a thermostat-controlled power vent. Heated air entering the attic will activate the power vent. Rework worksheet, adding the space of the adjoining unconfined space. The combined spaces must have enough fresh air to supply all appliances in both spaces.

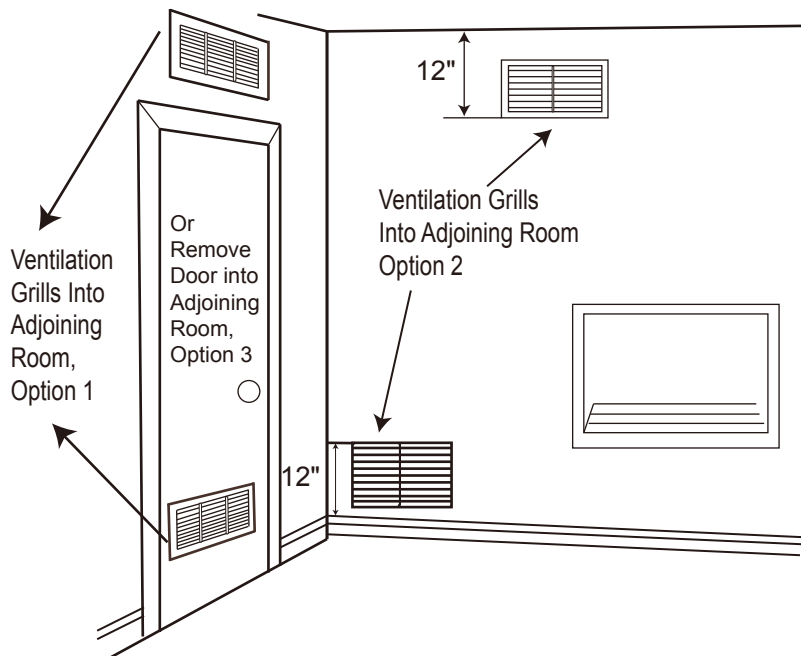

Figure 3 - Ventilation Air from Inside Building
NOTE: Base not included. Not for use in bedrooms or bathrooms.

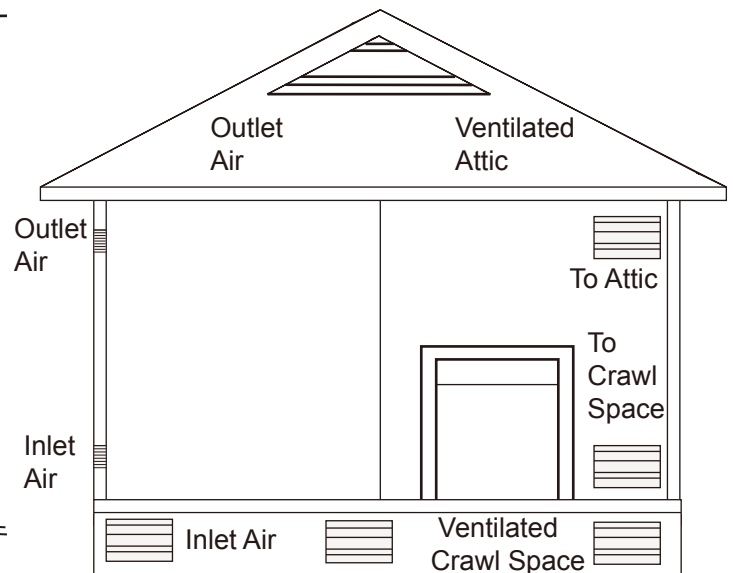

Figure 4 - Ventilation Air from Outdoors

INSTALLATION CONSIDERATIONS

This heater is intended for use as supplemental heat.

Use this heater along with your primary heating system. Do not install this heater as your primary heat source. If you have a central heating system, you may run system's circulating blower while using heater. This will help circulate the heat throughout the house. In the event of a power outage, you can use this heater as your primary heat source.

⚠ WARNING: A qualified service person must install heater. Follow all local codes.

⚠ WARNING: Never install the heater:

- in a recreational vehicle
- where curtains, furniture, clothing, or other flammable objects are less than 36 inches from the front, top, or sides of the heater
- in high traffic areas
- in windy or drafty areas

⚠ CAUTION: This heater creates warm air currents. These currents move heat to wall surfaces next to heater. Installing heater next to vinyl or cloth wall coverings or operating heater where impurities (such as tobacco smoke, aromatic candles, cleaning fluids, oil or kerosene lamps, etc.) in the air exist, may cause walls to discolor.

⚠ IMPORTANT: Vent-free heaters add moisture to the air. Although this is beneficial, installing heater in rooms without enough ventilation air may cause mildew to form too much moisture. See Air for Combustion and Ventilation.

Check Gas Type

Be sure your gas supply is right for your heater. Otherwise, call dealer where you bought the heater from for proper type heater.

Clearances to Combustibles

Carefully follow the instructions below. This heater is a freestanding floor seated unit.

⚠ WARNING: Maintain the minimum clearances shown in Figure 5. If you can, provide greater clearances from floor, ceiling, and joining wall.

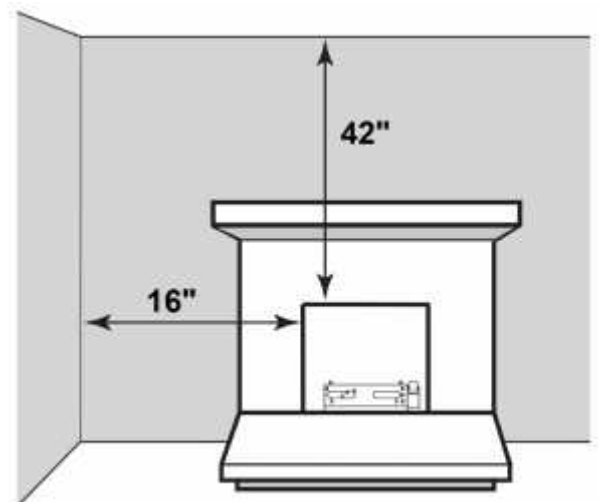

Figure 5 – Minimum Clearance to Combustibles

If Using Mantel

You must have noncombustible material(s) such as slate, marble, tile, etc. At least ½ in. thick. With sheet metal you must have noncombustible material behind it. Noncombustible material must extend at least 8 inches up. If noncombustible material is less than 12 inches, you must install the fireplace hood accessory. Even if noncombustible material is more than 12 inches, you may need the hood accessory to deflect heat away from mantel shelf. See Figure 6, 7 and 8.

Mantel Clearances

In addition to meeting noncombustible material clearances, you must also meet required clearances between fireplace opening and mantel shelf. If the clearances listed below are not met, you will need a hood.

Determining Mantel Clearances

If you meet minimum clearances requirements between mantel shelf and top of fire place opening, a hood is not necessary. See Figure 6

Determining Minimum Mantel Clearances When Using a Hood

If minimum clearance is Figure 7 are not met, you must have a hood. When using a hood there are still certain minimum clearances required. Follow minimum clearances shown in Figure 7 when using a hood.

The gas log heater must be installed at least 1 3/8" above any combustible flooring material, such as carpeting or tile, which is closer than 14" to the base of the fireplace. The minimum distance must be maintained from the top surface of carpeting, tile, etc. **See Figure 8.**

OR

The gas log heater may be installed nearer to the floor is a minimum of 14" of noncombustible material such as a slate or marble is installed between the base of the fire place and the combustible flooring. **See Figure 9.**

When installing your log set as a vent free installation the damper clamp can be used to eliminate the potential for odors when burning the logs for the first time.

IMPORTANT: If these minimum clearances are not met, you must operate heater with chimney flue damper open. Go to "Installing Damper Clamp", page 13.

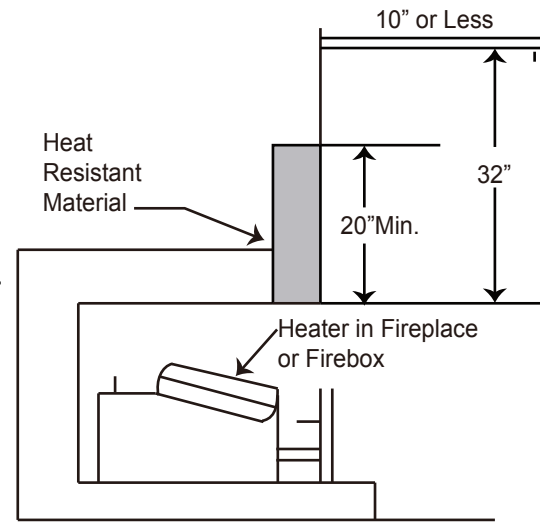

Figure 6 – Heat Resistance material with No Hood

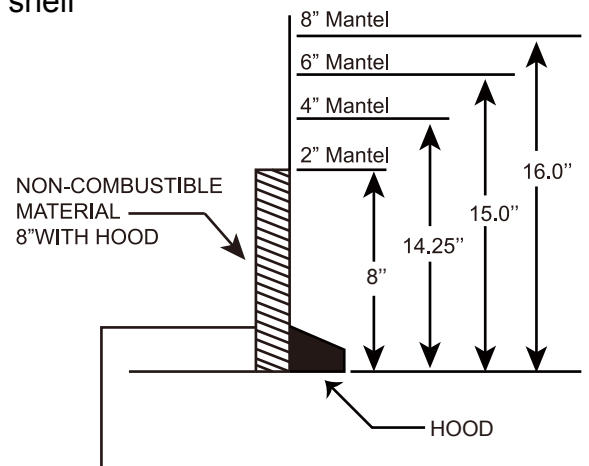

Figure 7 – Minimum mantel clearances with No Hood

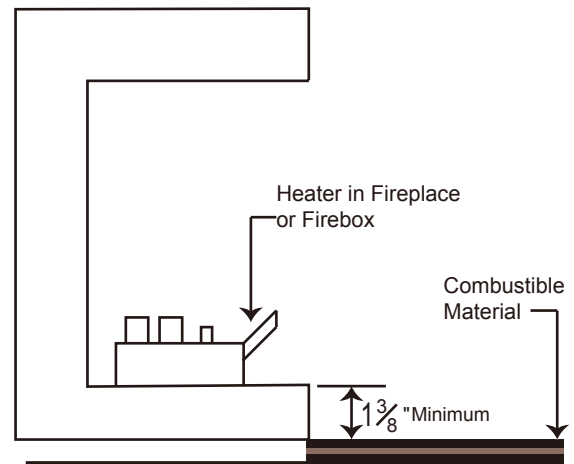

Figure 8 – Minimum Clearance Above Combustible Flooring.

Installing Damper Clamp

Remove all ashes or other debris from the fireplace. If the fireplace is equipped with an ash dump, be sure to seal the door with furnace cement or high temperature silicone. Be sure to check the damper for proper operation and verify that the flue passageway is open.

Place the clamp over the lip of the damper and tighten the hold down bolt until the clamp is securely attached to the damper. This will prevent the damper from accidentally closing.

Chimney damper must be fixed in a manner which will maintain the minimum permanent vent opening at all times. (Damper manufacture shall recommend means to accomplish this, such as by a screw or bolt in the edge of the damper to prevent its closing or by a hole or holes in the damper).

Manual and millivolt controlled gas logs may be installed as a vented decorative log set in compliance with ANSI Z21.60 and National Fuel Gas Code. When the gas logs are operated with the damper open, non-combustible material and minimum mantel requirements do not apply.

Note: When installing your log set as a vented installation the damper clamp (Not Provided in hardware) must be used.

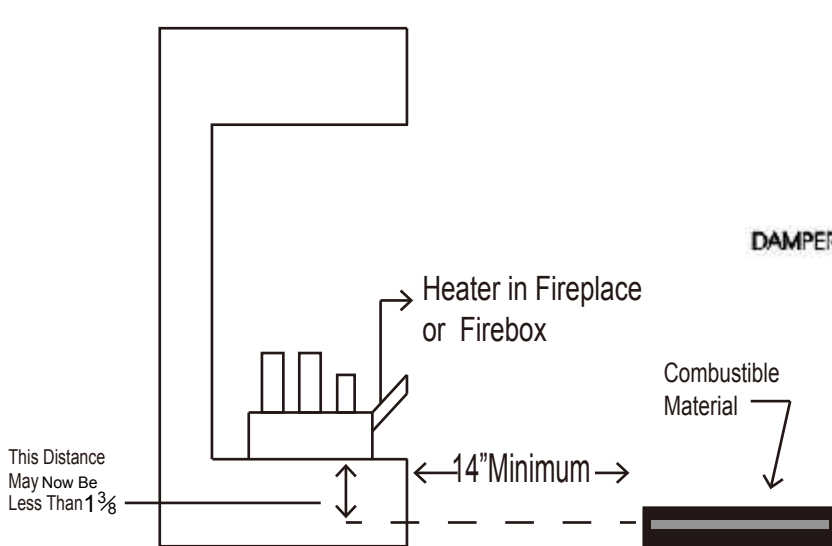

Figure 9 – Minimum Clearance Above Combustible Flooring with Noncombustible Material Installed at Base of Fireplace.

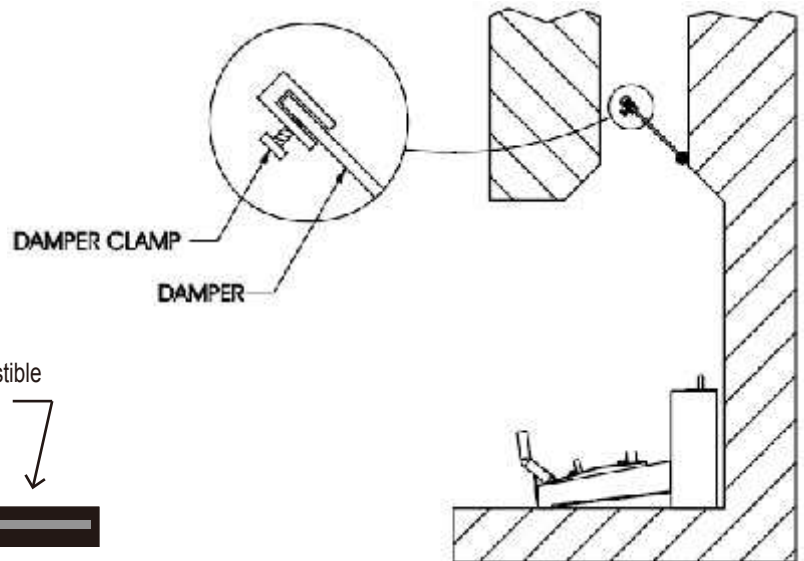

Figure 10 - Damper

Floor Clearances:

1. If installing appliance on the floor, you must maintain the minimum distance of 14 inches to combustibles (see Figure 9)
2. If combustible materials are less than 14 inches to the fireplace, you must install appliance at least 5 inches above the combustible flooring (See Figure 8)

Air Door

When using natural gas, a simple adjustment can be made to get the best yellow flame color and pattern possible. This adjustment controls the fuel to air ratio in your burner for the most realistic flame effect. The gas logs have a default setting on propane so an adjustment is only needed when using natural gas.

To adjust for Natural Gas, follow these instructions:

- Using a Philips head screwdriver, unscrew the outer panel
- Unscrew the Air Door
- Slide the Air Door all the way to the right, which assumes the Natural Gas setting
- Tighten the Air Door screw, so that it cannot move freely

In the event that you need to switch back to the Liquid Propane setting, simply loosen and shift the Air Door back to its original left position.

Note that no adjustment is necessary out of the box when using Liquid Propane as your fuel source

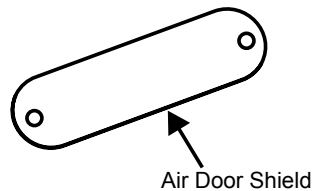
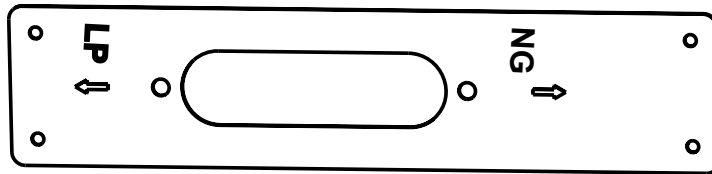

Minimum Firebox Dimensions

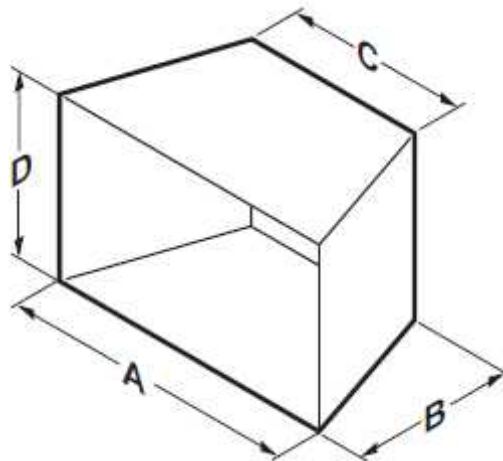

Model	Front Width	Length	Rear Width	Height
GLDF30M-V	34"	16"	32"	24"

Log Placement

Ensure that your heater's logs are placed as shown below. It's important that your logs do not cover burner holes, as this can lead to sooting and an overall drop in the performance of your heater. Logs should be placed sequentially, from lowest to highest, as the numbering indicates. There are grooves on many of the logs that allow for simple placement and help to prevent the logs from shifting positions.

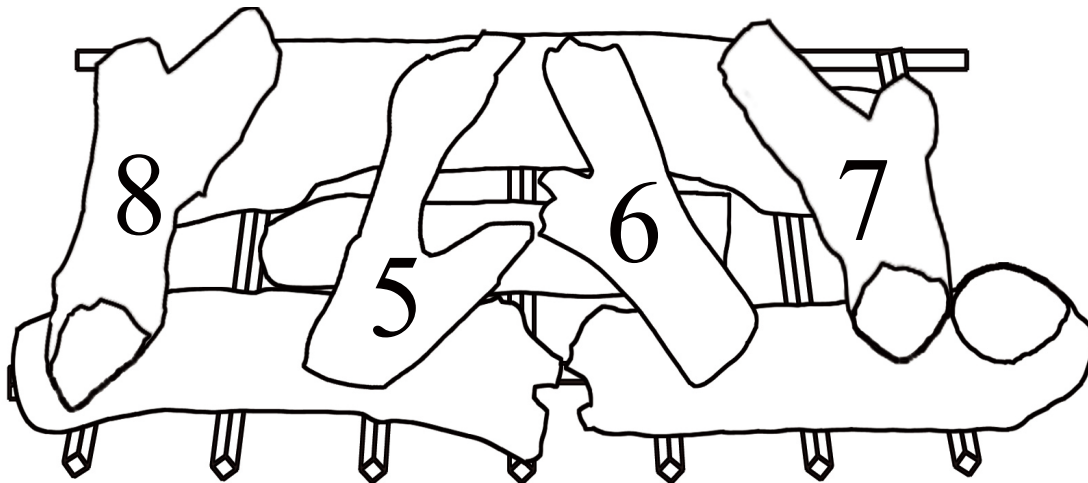
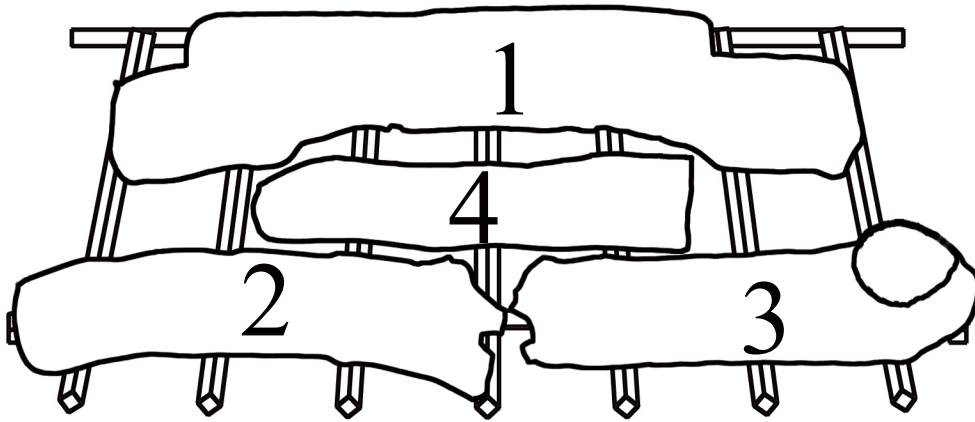

FIREPLACE PREPARATION

FOR FACTORY BUILT FIREPLACES

Free Opening Area of Chimney Damper For Venting Combustion Products From Decorative Appliances For Installation In Solid-Fuel Burning Fireplaces

	Appliance Input Rate (kBTU/hr)		
	30	40	50
Chimney Height* (ft)	Minimum Opening** (sq. in.)		
10	16.6	22.1	28.3
15	12.6	17.3	21.2
20	10.8	14.5	18.1
25	9.6	12.6	15.9
30	9.1	11.3	14.5
35	8.0	10.8	13.2
40	7.5	10.2	12.6

* Height is from hearth to top of chimney and the minimum height is 10 feet.

** Chart shows minimum opening (sq. in.) for the given height and input rate.

FOR MASONRY BUILT FIREPLACES

Free Opening Area Of Chimney Damper For Venting Combustion Products From Decorative Appliances For Installation In Solid-Fuel Burning Fireplaces

	Appliance Input Rate (kBTU/hr)		
	30	40	50
Chimney Height* (ft)	Minimum Opening** (sq. in.)		
6	25.7	33.8	41.7
8	23.7	31.2	38.7
10	21.7	28.7	35.2
15	19.9	26.1	32.0
20	18.5	23.7	28.8
30	16.9	21.6	26.5

* Height is from hearth to top of chimney and the minimum height is 6 feet.

** Chart shows minimum opening (sq. in.) for a given height and input rate.

CONNECTING TO GAS SUPPLY

WARNING: A qualified service technician must connect heater to gas supply. Follow the heater specification and all local codes. Wrong gas supply may result improper operation, or damage on your heater, property or/and personal body.

WARNING: This appliance requires a 5/8-inch UNF (Unified National Fine) inlet connection to the pressure regulator.

WARNING: Never connect heater to private (non-utility) gas wells. This gas is commonly known as wellhead gas.

WARNING: Do not over-tighten gas connections.

CAUTION: Use only new, black iron or steel pipe. Internally tinned copper tubing may be used in certain areas. Check your local codes. Use pipe of 1/2-in. diameter or greater to allow proper gas volume to heater. If pipe is too small, undue loss of pressure will occur.

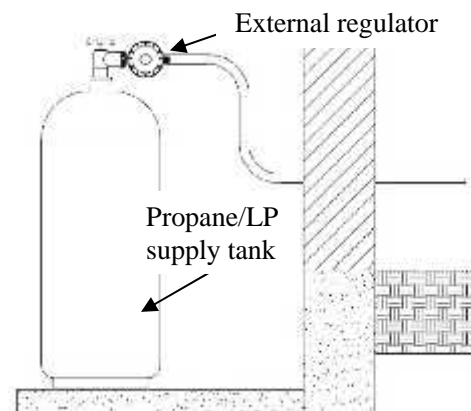

Figure 11 - External Regulator with Vent Pointing Down

NATURAL GAS MODELS:

CAUTION: Check your gas line pressure before connecting heater to gas line. Gas line pressure must be no greater than 8 inches of water column. If gas line pressure is higher, damage on appliance regulator could occur.

PROPANE MODELS:

CAUTION: Never connect heater directly to the gas supply. This heater requires an external regulator (not supplied). Install the external regulator between the heater and gas supply.

CAUTION: Avoid damage to regulator. Hold gas regulator with wrench when connecting into gas piping and/or fittings.

CAUTION: Use pipe joint sealant that is resistant to gas (Propane or Natural Gas).

IMPORTANT: Install an equipment shutoff valve in an accessible location where the gas pipe goes indoors. The equipment shutoff valve is for turning on or shutting off the gas to the appliance. Apply pipe joint sealant lightly to male threads. This will prevent excess sealant from going into pipe. Excess sealant in pipe could result in clogged heater valves. The installer must supply an external regulator with nominal outlet pressure of 11" water column and sufficient flow rates. Install external regulator with the vent pointing down as shown in Figure 11. Pointing the vent down protects it from freezing rain or sleet. If flexible gas hose is applied, it should meet the requirements of ANSI/UL569 Standard for Pigtail and Flexible Hose Connection for LP-Gas. Improper regulator and/or gas hose assembly may occur damage on your heater, property or/and personal body.

 **CAUTION:** Two gas lines installation at the same time is forbidden. Do not the open cover while the heater is running.

 **CAUTION:** To avoid gas leakage at the inlet of appliance regulator, a qualified installer or service technician must use steel or metal hex plug with sealant.

Changing from Liquid Propane to Natural Gas supply:

- 1) Your heater is equipped with a unique automatic gas source detection and configuration system, allowing it to perform using both liquid propane and natural gas without any manual conversion.
- 2) Only a qualified installer or service technician can perform gas type conversion from between liquid propane and natural gas supply. This is due to the type of connection and installation required external the heater.

CHECKING GAS CONNECTIONS

 **WARNING:** Test all gas piping and connections for leaks after installing or servicing. Correct all leaks at once.

 **WARNING:** Never use an open flame to check for a leak. Apply a mixture of liquid soap and water to all joints. If bubbles form, there is a leak. Correct all leaks at once.

Pressure Testing Gas Supply Piping System Test Pressures in Excess of 1/2 PSIG (3.5kPa)

1. Disconnect heater with its appliance main gas valve (control valve) and equipment shutoff valve from gas supply piping system. Pressures in excess of 1/2 PSIG will damage heater regulator.
2. Cap off open end of gas pipe where equipment shutoff valve was connected.
3. Pressurize supply piping system by either using compressed air or opening gas supply valve.
4. Check all joints of gas supply piping system. Apply mixture of liquid soap and water to gas joints. If bubbles form, there may be a leak.
5. Correct all leaks at once.
6. Reconnect heater and equipment shutoff valve to gas supply. Check reconnected fittings for leaks.

Test Pressures Equal to or Less Than 1/2 PSIG (3.5 kPa)

1. Close equipment shutoff valve
2. Pressurize supply piping system by either using compressed air or opening natural supply tank valve.
3. Check all joints from gas meter to equipment shutoff valve. Apply mixture of liquid soap and water to gas joints. If bubbles form, there is a leak.
4. Correct all leaks at once.

Pressure Testing Heater Gas Connections

1. Open equipment shutoff valve.
2. Open gas supply tank valve.
3. Make sure control knob of heater is in the OFF position.
4. Check all joints from equipment shutoff valve to control valve. Apply mixture of liquid soap and water to gas joints. If bubbles form, there may be a leak.
5. Correct all leaks at once.

UNIT OPERATION

FOR YOUR SAFETY READ BEFORE LIGHTING

 **WARNING:** If you do not follow these instructions exactly, a fire or explosion may result causing property damage, personal injury or loss of life.

1. When lighting the pilot, follow these instructions exactly.
2. BEFORE LIGHTING, smell all around the appliance area for gas. Be sure to smell next to the floor because some gas is heavier than air and will settle on the floor.
3. Use only your hand to push in or turn the gas control knob. Never use tools. If the knob will not push in or turn by hand, don't try to repair it, call a qualified service technician or gas supplier. Forced or attempted repair may result in a fire or explosion.
4. Do not use this appliance if any part has been under water. Immediately call a qualified service technician to inspect the appliance and to replace any part of the control system and any gas control which has been under water.

WHAT TO DO IF YOU SMELL GAS

- Open the window or door immediately.
- Do not try to light any appliance.
- Do not touch any electric switch, do not use any phone in your building.
- Immediately call your gas supplier from a neighbor's phone. Follow the gas supplier's instructions.
- If you cannot reach your gas supplier, call the fire department.

LIGHTING INSTRUCTIONS

Before Lighting:

1. Make sure the heater is properly installed and connected. Open the external safety shut off valve (not part of the heater) on gas inlet line to the heater.
2. Wait five (5) minutes to clear out air inside gas lines. Smell if there is any leakage.

IMPORTANT: If you smell any gas, do not try to light any appliances, do not touch electrical switches or use any phone in the building. Shut off the valve on gas inlet line immediately and contact gas supplier from a neighbor's phone. Follow gas supplier's instructions. If you can't reach the gas supplier, call the fire department. Only when you make sure there is no gas leakage, go to the next step.

Note: During first seasonal use, gas smell is expected to be more noticeable than in standard operation.

Ignition Process:

1. During the first seasonal operation, set the Control Knob to Pilot, then hold down on the Control Knob for 3-5 minutes. This allows the air in the manifolds to clear completely. During normal operation, you will only need to hold the Control Knob down on Pilot for about 5 seconds.
2. With the Control Knob set to Pilot, push down on both the Igniter Button and the Control Knob simultaneously until ignition can be heard. Continue to hold down both buttons for at least 15 seconds, until the pilot is touching the thermocouple and is noticeably heated.
3. Release both buttons. Should the pilot go out, repeat steps 2 and 3.
4. Once the pilot flame is stable, turn the Control Knob counterclockwise  from the Pilot setting to the desired number setting. This should be done slowly in one motion, without stopping between positions. Knob will only turn if you have a stable pilot light.
5. The heater will now operate normally. Room temperature will vary based on individual room size and installation.

Shutdown Process:

To stop the heater, shut off the safety valve on the gas inlet line. Next, turn the Control Knob to the OFF position.

INSPECTING BURNER

Check pilot flame pattern and burner flame pattern often (see Figure 13 and Figure 14 for reference).

PILOT FLAME PATTERN

Two pilot burners with ODS function for NAT and LP gas respectively are installed on burners two sides separately as shown in Figure. 13. The normal ODS pilot flame should have a correct pattern as shown in Figure 14 in normal operation with exception during ignition stage.

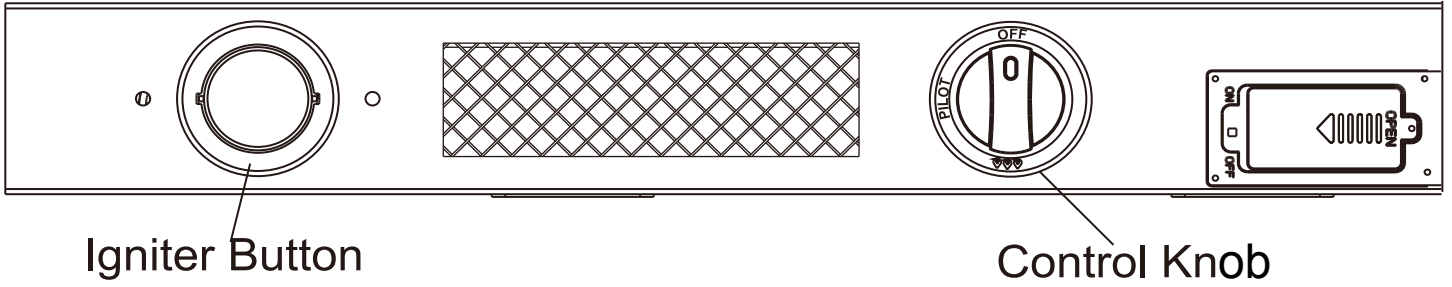

Figure 12 – Control Panel

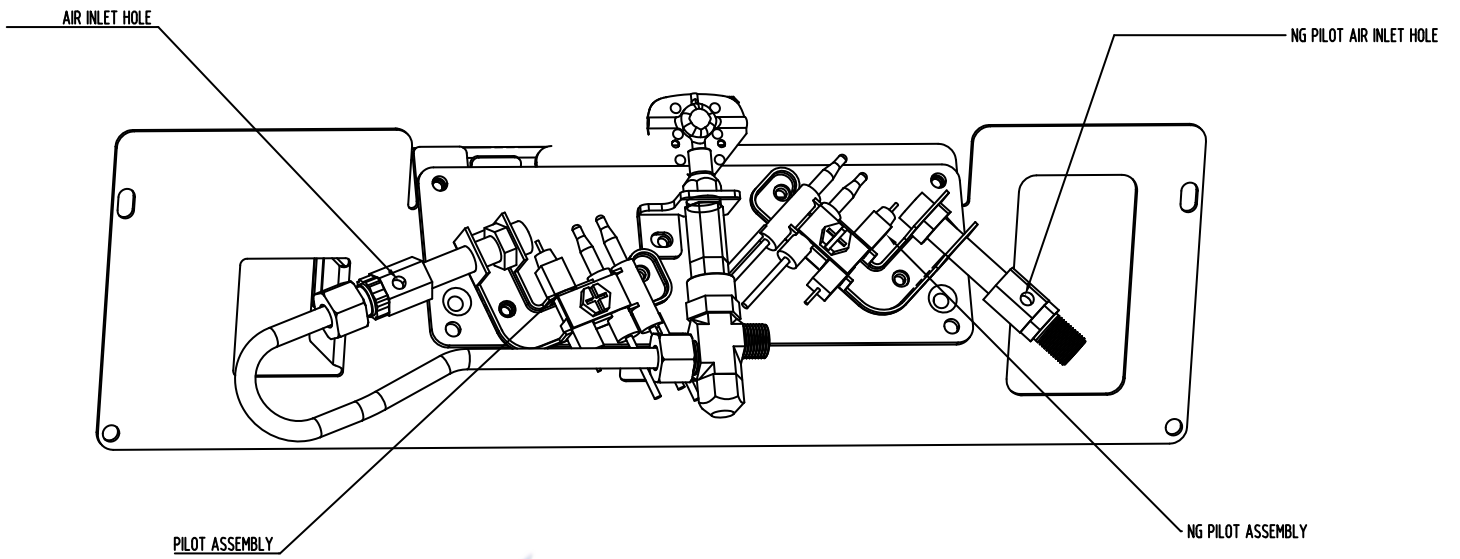

Figure 13 – Pilot System

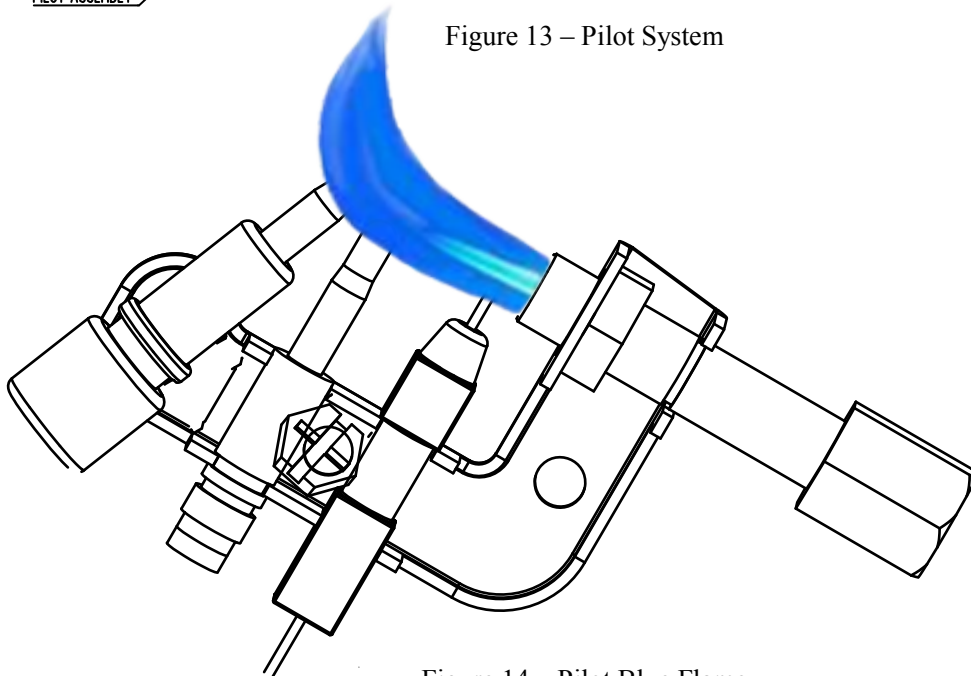



Figure 14 – Pilot Blue Flame

CARE AND MAINTENANCE

 **WARNING:** Turn off heater and let cool before servicing

 **CAUTION:** You must keep control areas, burner, and circulating air passageways of the heater clean. Inspect these areas of heater before each use. Have heater inspected yearly by a qualified service technician. Heater may need more frequent cleaning due to excessive lint from carpeting, bedding material, pet hair, etc.

ODS/PILOT AND BURNER

Use a vacuum cleaner, pressurized air, or a small, soft bristled brush to clean.

CLEANING BURNER PILOT AIR INLET HOLE

We recommend that you clean the unit every 2,500 hours of operation or every three months. We also recommend that you keep the burner tube and pilot assembly clean and free of dust and dirt. To clean these parts, we recommend using compressed air no greater than 30 PSI. Your local computer store, hardware store, or home center may carry compressed air in a can. You can use a vacuum cleaner in the blow position. If using compressed air in a can, please follow the directions on the can. If you don't follow directions on the can, you could damage the pilot assembly.

1. Shut off the unit, including the pilot. Allow the unit to cool for at least thirty minutes.
2. Inspect burner and pilot for dust and dirt.
3. Blow air through the ports/slots and holes in the burner. Also clean the pilot assembly. A yellow tip on the pilot flame indicates dust and dirt in the pilot assembly. There is a small pilot air inlet hole about two inches from where the pilot flame comes out of the pilot assembly (see Figure 13). With the unit off, lightly blow air through the air inlet hole. You may blow through a drinking straw if compressed air is not available.

CABINET

Air Passageways

Use a vacuum cleaner or pressurized air to clean.

Exterior

Use a soft cloth dampened with a mild soap and water mixture.

Wipe the cabinet to remove dust

- 1) Use a soft cloth dampened with a mild soap and water mixture.
- 2) Wipe the cabinet to remove dust.

TROUBLESHOOTING



WARNING:

If you smell gas:

- Open the window and door immediately.
- Shut off gas supply.
- Do not try to light any appliance.
- Do not touch any electrical switch; do not use any phone in your building.
- Immediately call your gas supplier from a neighbor's phone. Follow the gas supplier's instructions.
- If you cannot reach your gas supplier, call the fire department.



IMPORTANT: Operating heater where impurities in air exist may create odors. Cleaning supplies, paint, paint remover, cigarette smoke, cements and glues, new carpet or textiles, etc., create fumes. These fumes may mix with combustion air and create odors.



WARNING: Only a qualified service technician should service and repair heater.



CAUTION: Never use a wire, needle, or similar object to clean ODS/pilot. This can damage ODS/pilot unit. Note: All troubleshooting items are listed in order of operation.

PROBLEM	POSSIBLE CAUSE	CORRECTIVE ACTION
<ul style="list-style-type: none"> ➤ When igniter knob is pressed in there is no spark at ODS/pilot. 	<ul style="list-style-type: none"> • Igniter electrode is positioned wrongly. • Cables between switch, battery pack, igniter and igniter electrode may be loose, pinched, wet or broken. • Bad igniter • No battery or battery used out. 	<ul style="list-style-type: none"> • Reposition igniter electrode. • Secure or replace cables between switch, battery pack, igniter and igniter electrode. • Replace igniter. • Install or replace battery.
<ul style="list-style-type: none"> ➤ When igniter knob is pressed in there is a spark at ODS/pilot but no ignition. 	<ul style="list-style-type: none"> • Gas supply is turned off or equipment shutoff valve is closed. • Control knob not fully pressed in while pressing igniter button. • Air in gas lines when installed. • ODS/pilot is clogged. • Control knob not in PILOT position. • External shut off valve on gas supply opened too fast and blocked appliance regulator in heater. 	<ul style="list-style-type: none"> • Turn on gas supply or open equipment shutoff valve. • Fully press in control knob while pressing igniter button. • Continue holding down control knob. Repeat igniting operation until air is removed. • Clean ODS/pilot or replace ODS/pilot assembly. • Turn control knob to PILOT position. • Close external shut off valve and re-open slowly.
<ul style="list-style-type: none"> ➤ ODS/pilot lights but flame goes out when control knob is released. 	<ul style="list-style-type: none"> • Both control and igniter knobs are not fully pushed down. • Thermocouples are not heated enough. • External shutoff valve of gas supply is not fully opened. • Thermocouple connections are loose or damaged. • Control valve damaged. 	<ul style="list-style-type: none"> • Press in both the igniter and pilot knobs fully. While holding igniter down, set control knob to number 5. Run heater for 15 minutes. • After ODS/pilot lights, keep both knobs depressed for at least 15 seconds. • Fully open equipment shutoff valve. • Secure or replace thermocouple connections. • Contact customer service.
<ul style="list-style-type: none"> ➤ Burner(s) does not light after ODS/pilot is lit stably 	<ul style="list-style-type: none"> • Burner orifice is clogged. • Burner orifice diameter is too small. • Inlet gas pressure is too low. 	<ul style="list-style-type: none"> • Clean burner orifice or replace burner orifice. • Contact customer service. • Contact local gas supplier.
<ul style="list-style-type: none"> ➤ Delayed ignition of burner(s). 	<ul style="list-style-type: none"> • Manifold pressure is too low. • Burner orifice is clogged. 	<ul style="list-style-type: none"> • Contact local gas supplier. • Clean or replace burner orifice.
<ul style="list-style-type: none"> ➤ Burner backfiring during combustion. 	<ul style="list-style-type: none"> • Burner orifice is clogged. • Burner is damaged. • Gas regulator or/and appliance regulator are defective. 	<ul style="list-style-type: none"> • Clean burner using compressed air or replace burner orifice. • Contact customer service. • Contact customer service.
<ul style="list-style-type: none"> ➤ Slight smoke or odor during initial operation. 	<ul style="list-style-type: none"> • Residues from manufacturing processes. 	<ul style="list-style-type: none"> • Problem will dissipate after a few hours of operation in high setting. Ensure appropriate ventilation during this time.

➤ Heater produces a whistling noise when burner is lit.	<ul style="list-style-type: none"> • Turning control knob to Hi position when burner is cold. • Air in gas line. • Air passageways on heater are blocked. • Dirty or partially clogged burner orifice. 	<ul style="list-style-type: none"> • Turn control knob to LO position and let warm up for a minute. • Operate burner until air is removed from line. Have gas line checked by local gas supplier. • Observe minimum installation clearances • Clean or replace burner.
➤ Heater produces a clicking/ ticking noise just after burner is lit or shut off.	<ul style="list-style-type: none"> • Metal is expanding while heating or contracting while cooling. 	<ul style="list-style-type: none"> • This is common with most heaters. If noise is excessive, contact qualified service technician.
➤ White powder residue forming within burner box or on adjacent walls or furniture.	<ul style="list-style-type: none"> • When heated, the vapors from furniture polish, wax, carpet cleaners, etc., turn into white powder residue. 	<ul style="list-style-type: none"> • Turn heater off when using furniture polish, wax, carpet cleaner, or similar products.
➤ Heater produces unwanted odors.	<ul style="list-style-type: none"> • Heater is burning vapors from paint, hair spray, glues, etc. See IMPORTANT statement. • Gas leak. See Warning Statement • Low fuel supply. 	<ul style="list-style-type: none"> • Ventilate room. Stop using odor causing products while heater is running. • Locate and correct all leaks. • Refill supply tank (Propane / LP models).
➤ Heater shuts off in use (ODS operates).	<ul style="list-style-type: none"> • Not enough fresh air is available. • Low line pressure. • ODS/pilot is partially clogged. 	<ul style="list-style-type: none"> • Open window and/or door for ventilation. • Contact local gas supplier. • Clean ODS/pilot
➤ Gas odor during combustion	<ul style="list-style-type: none"> • Gas leak. See Warning Statement • Control valve is defective. • Foreign matters in heater 	<ul style="list-style-type: none"> • Locate and correct all leaks. • Contact customer service. • Remove foreign matters
➤ Unexpected moisture/condensation noticed on windows.	<ul style="list-style-type: none"> • Ambient moisture is too high, • Not enough ventilation 	<ul style="list-style-type: none"> • Use a dehumidifier, • Refer to “Air for Combustion and Ventilation Requirements”

ILLUSTRATED PARTS (Model: GLDF30M-V)

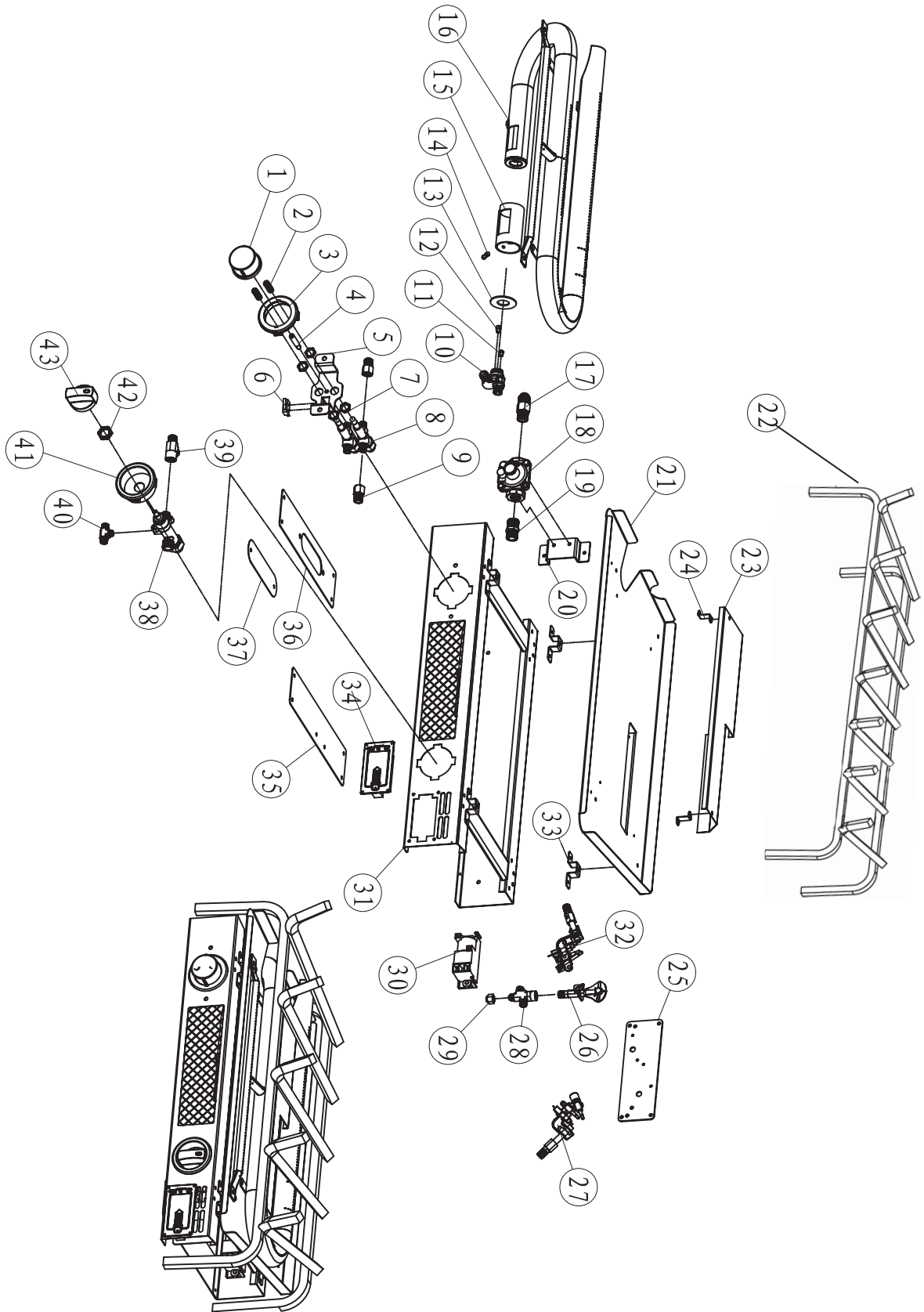

PARTS LIST (Model: GLDF30M-V)

Code	Description	Code	Description
1	Ignition button	23	ODS wind shield
2	Spring	24	ODS wind shield bracket
3	Button seat	25	ODS fixing bracket
4	Guiding rod	26	Pilot burner
5	Gas choosing bracket	27	NG ODS assembly
6	Igniter micro switch	28	Four-way joint
7	Screw	29	Four-way joint insert
8	Gas source detecting valve	30	Pulse igniter
9	Pipe transition joint	31	Frame assembly
10	Nozzle seat	32	LP ODS
11	LPG Nozzle	33	Chamber spacer
12	NG Nozzle	34	Battery pack
13	Air door washer	35	Bottom Strengthen strip No. 2
14	Air door rod	36	Bottom Strengthen strip No. 1
15	Air shutter	37	Air door shield
16	Burner	38	Main gas valve
17	Appliance regulator valve connector No.1	39	T-joint No. 1
18	Appliance regulator valve	40	T-joint No. 2
19	Appliance regulator valve connector No.2	41	Main gas valve seat
20	Appliance regulator valve bracket	42	Main gas valve screw
21	Insulation board	43	Main gas valve knob
22	Grate		

Parts Not Sold Separately

Questions about installation and initial operation should be directed to your installer. For all other concerns and questions, please reach out to our customer service team at 1-877-670-8428, by email at service@thermablaster.com, or visit www.thermablaster.com

Annual Service Schedule

Service Performed	Service Date

Please **register** your product online at www.thermablaster.com, or send in the registration form below to our office at:

Reecon North America
 2515 Liberty Ave
 Pittsburgh, PA 15222

Contact Information

Product Information

Name:	Model:
Phone:	Serial Number:
Email:	Date of Purchase:
Address:	Retailer Purchased from:
City:	Installer Company:
State:	Installer Phone:
Zip Code:	Installer Zip Code:

****All information above is required in order for our company to honor the warranty****

Comments:



Thermablaster[®]

BY *Reecon*