



# Thermablaster®



## Infrared Cabinet Heater

### Product Manual

#### MODEL: RC9200IT





### CAUTION - FOR YOUR SAFETY

 <h2>DANGER</h2>	<p><b>CARBON MONOXIDE HAZARD</b></p> <p>This appliance can produce carbon monoxide which has no odor.</p> <p>Using it in an enclosed space can kill you.</p> <p>Never use this appliance in an enclosed space such as a camper, tent or home.</p>
	

 **WARNING:** Do not use in windy conditions

 **WARNING:** For Outdoor Use Only.

 **WARNING:** Improper installation, adjustment, alteration, service or maintenance can cause property damage, injury or death. Read the installation, operating and maintenance instructions thoroughly before installing or servicing this equipment.

 **DANGER**

If you smell gas:

1. Shut off gas to the appliance.
2. Extinguish any open flame.
3. If odor continues, keep away from the appliance and immediately call your gas supplier or fire department.

 **WARNING**

Do not store or use gasoline or other flammable vapors and liquids in the vicinity of this or any other appliance.

An LP-cylinder not connected for use shall not be stored in the vicinity of this or any other appliance.

**Reecon North America, L.L.C.**  
 1090 Freeport Road  
 2<sup>nd</sup> Floor  
 Pittsburgh, PA 15238

**The installer should leave the instructions with the consumer**  
**The consumer should retain the instructions for future reference**

# PRODUCT SPECIFICATIONS

<b>Model</b>	RC9200IT
<b>BTU ( available )</b>	32,000 BTU(9.2Kw)
<b>Gas type</b>	LP
<b>Pressure regulator setting</b>	11 WC
<b>Maximum Inlet Gas Supply Pressure</b>	11 WC
<b>Ignition</b>	Electric Piezo
<b>Heat Setting</b>	2 stage (Hi/Low)

## 1. IMPORTANT SAFETY INFORMATION

**IMPORTANT:** Read this owner's manual carefully and completely before trying to assemble, operate, or service this heater. Improper use of this heater can cause serious injury or death from burns, fire, explosion, electrical shock, and carbon monoxide poisoning. Only a qualified installer, service agent, or local gas supplier may install and service this product.

 **WARNING:** Do not store or use gasoline or other flammable vapors and liquids in the vicinity of this or any other appliance.

**CARBON MONOXIDE POISONING:** Early signs of carbon monoxide poisoning resemble the flu with headache, dizziness and/or nausea. If you have these signs, heater may not be working properly. Get fresh air at once! Have heater serviced. Some people - pregnant women, persons with heart or lung disease, anemia, those under the influence of alcohol, those at high altitude - are more affected by carbon monoxide than others.

**WARNING:** Any change to this heater or its controls can be dangerous.









 **WARNING:** Do not use any accessories not approved for use with this heater.

 **WARNING:** Carefully supervise young children when they are in the area with the heater.

 **WARNING:** Make sure both grill guards are in place before running the heater.(see diagram page 4)

 **WARNING:** Keep the appliance area clear and free from combustible materials, gasoline, and other flammable vapors and liquids.

 **WARNING:** Due to high temperatures, the appliance should be located out of traffic and away from furniture and draperies.

-  **WARNING:** Certain materials or items, when stored under the heater, will be subjected to radiant heat and could be seriously damaged.
-  **WARNING:** Heater becomes very hot when running. Keep children and adults away from hot surfaces to avoid burns or clothing ignition. Heater will remain hot for a time after shutoff. Allow surfaces to cool before touching.
-  **WARNING:** Do not place clothing or other flammable material on or near the appliance. Never place any objects in the heater.
-  **WARNING:** Failure to keep the primary air opening(s) of the burn(s) clean may result in sooting and property damage.
-  **WARNING:** Do not allow fans to blow directly into the heater. Avoid any drafts that alter burner flame patterns.
-  **WARNING:** Do not use a blower insert, heat exchanger insert or other accessory not approved for use with this heater
-  **WARNING:** Failure to position the parts in accordance with these diagrams or failure use only parts specifically approved with this heater may result in property damage or personal injury.
-  This heater needs fresh air ventilation to run properly. This heater has an Oxygen Depletion Sensing (ODS) safety shutoff system. The ODS shuts down the heater if not enough fresh air is available. See Air for Combustion and Ventilation.

**DO NOT RUN HEATER:** Where flammable liquids or vapors are used or stored or under dusty conditions.

Always run heater with control knob locked positions. Never set control knob between locked positions. Poor combustion and higher levels of carbon monoxide may result.

Periodic visual check of pilot and burner flame, are necessary for proper operation.

### **QUALIFIED INSTALLING AGENCY**

Only a qualified agency should install and replace gas piping, gas utilization equipment or accessories, and repair and equipment servicing. The term “qualified agency” means any individual, firm, corporation, or company that either in person or through a representative is engaged in and is responsible for:

a) Installing, testing, or replacing gas piping or

b) Connecting, installing, testing, repairing, or servicing equipment; that is experienced in such work; that is familiar with all precautions required; and that has complied with all the requirement of the authority having jurisdiction.

## 2. PRODUCT FEATURES

### SAFETY PILOT

This heater has a pilot with an Oxygen Depletion Sensing (ODS) safety shutoff system. The ODS pilot shuts off the heater if there is not enough fresh air.

### TIP OVER SWITCH

This heater is equipped with a safety tip over switch in the event the heater is knocked over.

### PIEZO IGNITION SYSTEM

This heater is equipped with an electronic piezo control system.

## 3. PREPARING FOR INSTALLATION

Before beginning assembly or operation of the product, make sure all parts are present. Compare parts with package contents list and diagram below. If any part is missing or damaged, do not attempt to assemble, install or operate the product. Contact customer service for replacement parts.

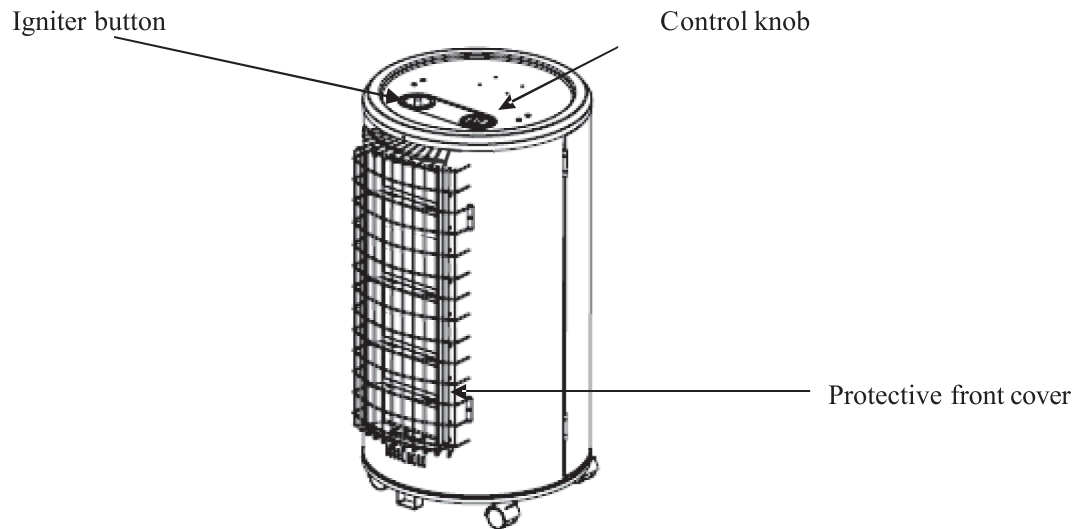

Figure 1 – gas heater cabinet

## UNPACKING

1. Remove heater from carton.
2. Remove all protective packaging applied to heater for shipping
3. Check heater for any shipping damage. If heater is damaged, promptly inform dealer where you bought heater.

## 4. INSTALLATION

**⚠ WARNING:** A qualified service person must install heater. Follow all local codes.

### Check Gas Type

Be sure your gas supply is right for your heater. Otherwise, call dealer where you bought the heater for proper type heater.

### Connect Hose & Regulator to Cylinder

1) You must provide propane gas and propane cylinder. Use a standard 20 lb. propane cylinder. (See figure 2)

2) Use this heater only with a propane vapor withdrawal supply system. See chapter 5 of the standard for storage and handling of liquefied petroleum Gas, ANSI/NFPA58. Your local library or fire department should have this book.

3) The minimum permissible gas supply inlet pressure of 11 W.C. is required for purpose of input adjustment.

4) The normal hourly of 32,000BTU is required input rating for a heater for automatic operation at ratings less than full input rating.

5) The pressure regulator and hose assembly supplied with the appliance **must** be used.

6) The regulator hose must be attached to the tank and the heater inside the heater cabinet. This will make sure the hose is located out of pathways where people may trip over it or in areas where the hose may be subject to accidental damage.

7) The installation must conform with local codes, or in the absence of local codes, with National Fuel Gas Code, ANSI Z223.1.

### 8) LP-gas supply cylinder to be used must be:

(a) Constructed and marked in accordance with the Specifications for LP-gas cylinders of the U.S. Department of Transportation (DOT); or the Standard for Cylinders, Spheres and Tubes for Transportation of Dangerous Goods and Commission, CAN/CSA-B339, as applicable;

(b) Provided with a listed overfilling prevention device; and

(c) Provided with a cylinder connection device compatible with the connection for the appliance.

9) A dented, rusted or damaged propane cylinder may be hazardous and should be checked by your cylinder supplier. Never use a propane cylinder with a damaged valve connection.

10) The propane cylinder must be constructed and marked in accordance with the specifications for LP gas cylinders of the U.S. Department of Transportation (DOT).

11) Never connect an unregulated propane cylinder to the heater.



Figure 2 – propane cylinder



figure 3

12) Screw regulator onto gas hose. Do not cross-thread. (see figure 3)

13) Tighten securely.

14) Attach regulator to cylinder. (see figure 4)

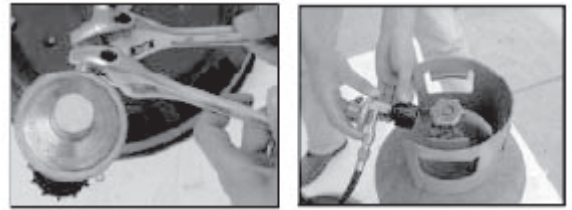

figure 4

15) Complete attachment.

16) Install the cylinder and latch closed. (see figure 5)

17) Close the rear cover.

18) Attach the primary protective grill using the screws provided with the heater. Ensure all screw holes on both sides of the top and bottom of the grill are securely fastened to the heater. (Please see diagram on page 14 showing the grill and its attached position to the heater)



figure 5

## CHECKING GAS CONNECTIONS

 **WARNING:** Test all gas piping and connections for leaks after installing or servicing. Correct all leaks at once.

 **WARNING:** Never use an open flame to check for a leak. Apply a mixture of liquid soap and water to all joints. If bubbles form, there is a leak. Correct all leaks at once.

## Pressure Testing Heater Gas Connections

- 1) Open equipment shutoff valve.
- 2) Open gas supply tank valve.
- 3) Make sure control knob of heater is in the OFF position.
- 4) Check all joints from equipment shutoff valve to control valve. Apply mixture of liquid soap and water to gas joints. If bubbles form, there may be a leak.
- 5) Correct all leaks at once.

## 5. AIR FOR COMBUSTION AND VENTILATION

This heater is equipped with multiple ventilation holes in and around the heater. The following MUST be adhered to when using this heater:

- 1) Adequate clearance MUST always be provided for the air opening around the heater.
- 2) Adequate air MUST be provided into the combustion chamber.
- 3) This heater MUST always be kept clear of ANY combustible material.

The following are the minimum clearances from combustibles:

- 1) **4 inches** from the floor
- 2) **5 feet** from ANY wall or railing
- 3) **8 feet** from the ANY ceiling or overhead cover

**USER MUST NEVER OPERATE THE HEATER WITH ANY VENT COVERED TO ALLOW ADEQUATE FRESH AIR INTO THE HEATER AND COMBUSTION CHAMBER**

## 6. OPERATION

### FOR YOUR SAFETY READ BEFORE LIGHTING

 **WARNING:** If you do not follow these instructions exactly, a fire or explosion may result causing property damage, personal injury or loss of life.

### Before Turning Gas Supply ON:

- 1) Your heater was designed and approved for outdoor use only. Do NOT use it inside a building, garage, or any other enclosed area.
- 2) Make sure surrounding areas are free of combustible materials, gasoline, and other flammable vapors or liquids.
- 3) Ensure that there is no obstruction to air ventilation.
- 4) Be sure all gas connections are tight and there are no leaks by using soap on the hose. No bubbles should be seen. If you see bubbles then the connection is not secure.
- 5) **Inspect the gas pressure regulator and hose prior to each use. (if there is evidence of excessive abrasion or wear, or if the hose is damaged DO NOT USE THE HEATER. The user MUST replace the hose with the manufacture specified replacement hose and regulator)**
- 6) Regulator Hose should be connected at the top of the propane cylinder and attached directly to the heater out of the way area where accidental damage could occur.
- 7) **ONLY the pressure regulator and hose assembly supplied with the appliance must be used**
- 8) Be sure the cylinder cover is clear of debris.
- 9) Be sure any component remove during assembly or servicing is replaced & fastened prior to starting.

## Before lighting

- 1) Heater should be thoroughly inspected before each use and by a qualified service person at least annually.
- 2) If relighting a hot heater, always wait at least 5 minutes
- 3) Inspect the hose assembly for evidence of excessive abrasion, cuts, or wear. Suspected areas should be leak tested. If the hose leaks, it must be replaced prior to operation. Only use the replacement hose assembly specified by manufacturer.

## Lighting

- 1) STOP! Read the safety information on the inside of the heater. User MUST follow these lighting procedures or the heater will NOT operate properly.
- 2) Make sure equipment shutoff valve is fully open.
- 3) Turn control knob clockwise to the OFF position.
- 4) Wait five (5) minutes to clear out any gas. Then smell for gas, including near the floor. If you smell gas, STOP! Do not try to light any appliance. Do not touch electrical switch or use any phone in the building. Immediately contact gas supplier from a neighbor's phone. Follow gas supplier's instructions. If you can't reach the gas supplier, call the fire dept. If you don't smell gas, go to the next step.
- 5) Turn control knob counterclockwise to the START position. Press in control knob for five (5) seconds (see the follow Figure 6) and simultaneously press the igniter button. This will light the pilot. The user must verify the pilot is lit prior to turning the knob to the first flame position. In the event the pilot is not lit you must wait 5 minutes to relight.
- 6) Turn control knob to single flame symbol. This will light the bottom 3 ceramic plaques.
- 7) Turn the knob again to the double burner symbol and this will light the upper 3 ceramic plaques. (it is best to allow the bottom 3 plaques to warm up first prior to turning the top plaques on.)



figure 6



figure 6.1

## Shut down

- 1) Turn control knob clockwise to START (normally, burner will make a slight popping sound when extinguished.)
- 2) To extinguish pilot, depress control knob and continue to turn it clockwise to OFF.
- 3) Turn cylinder valve clockwise to OFF and disconnect regulator when heater is not in use.

## After operation check:

- 1) Gas control is in OFF position.
- 2) Gas Tank valve is OFF.
- 3) Disconnect gas hose by unscrewing the plastic end attached to the cylinder.
- 4) Heater is upright in a secure location.
- 5) Storage of an appliance indoors is permissible only if the cylinder is disconnected and removed from the appliance.
- 6) A cylinder must be stored outdoors in a well-ventilated area out of the reach of children
- 7) A disconnected cylinder must have dust caps tightly installed and must not be stored in a building, garage or any other enclosed area.

## 7. CARE AND MAINTENANCE

**WARNING:** Turn off heater and let cool before servicing. Any grills removed for servicing **MUST** be replaced prior to use.

**CAUTION:** You must keep control areas, burner, and circulating air passageways of heater clean. Inspect these areas of heater before each use. Have heater inspected yearly by a qualified service technician. Heater may need more frequent cleaning due to dirt and other debris normally found outdoors.

**CAUTION:** The appliance is equipped with a piezo electric operated ignition device. The user **MUST** follow the proper lighting instructions or damage to the heater or fire may occur.

### CLEANING ODS/PILOT AND BURNER

Use a vacuum cleaner, pressurized air, or a small, soft bristled brush to clean.

## **CLEANING BURNER PILOT AIR INLET HOLE**

We recommend that you clean the unit every 2,500 hours of operation or every three months. We also recommend that you keep the burner tube and pilot assembly clean and free of dust and dirt. To clean these parts we recommend using compressed air no greater than 30 PSI. Your local computer store, hardware store, or home center may carry compressed air in a can. You can use a vacuum cleaner in the blow position. If using compressed air in a can, please follow the directions on the can. If you don't follow directions on the can, you could damage the pilot assembly.

- 1) Shut off the unit, including the pilot. Allow the unit to cool for at least thirty minutes.
- 2) Inspect burner and pilot for dust and dirt.
- 3) Blow air through the ports/slots and holes in the burner and clean the pilot assembly. A yellow tip on the pilot flame indicates dust and dirt in the pilot assembly. There is a small pilot air inlet hole about two inches from where the pilot flame comes out of the pilot assembly (see figure 7). With the unit off, lightly blow air through the air inlet hole. You may blow through a drinking straw if compressed air is not available.
- 4) With the unit on, visually check the burner flames to verify an even orange pattern on ALL 6 burners. Compare with figure 7 below.

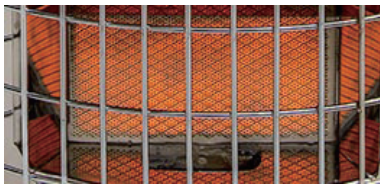

Insert air cleaning device through grill to clean burner holes

Figure 7

## **CLEANING THE CABINET**

### **Air Passageways**

Use a vacuum cleaner or pressurized air to clean.

### **Exterior**

Use a soft cloth dampened with a mild soap and water mixture.

Wipe the cabinet to remove dust.

If you need replacement parts you must go to an authorized dealer for professional service! Every part of the heater shall be secure against displacement and shall be constructed to maintain a fixed relationship between essential parts under normal and reasonable conditions of handling and usage. Parts not permanently secured shall be designed so they cannot be incorrectly assembled and cannot be improperly located or misaligned in removing or replacing during cleaning or other servicing.

## 8. TROUBLE SHOOTING

**WARNING:** If you smell gas:

- 1) Open the window and door immediately.
- 2) Shut off gas supply.
- 3) Do not try to light any appliance.
- 4) Do not touch any electrical switch; do not use any phone in your building.
- 5) Immediately call your gas supplier from a neighbor's phone. Follow the gas supplier's instructions.
- 6) If you cannot reach your gas supplier, call the fire department.

**IMPORTANT:** Operating heater where impurities in air exist may create odors. Cleaning supplies, paint, paint remover, cigarette smoke, cements and glues, new carpet or textiles, etc., create fumes. These fumes may mix with combustion air and create odors.

**WARNING:** Only a qualified service technician should service and repair heater.

**CAUTION:** Never use a wire, needle, or similar object to clean ODS pilot. This can damage ODS pilot unit. Note: All troubleshooting items are listed in order of operation.

No.	PROBLEM	POSSIBLE CAUSE	REMEDY
1	When igniter button is pressed in there is no spark at ODS/pilot.	<ol style="list-style-type: none"> <li>1. Igniter electrode is positioned wrong or broken.</li> <li>2. Igniter electrode is not connected to igniter cable.</li> <li>3. Igniter cable is pinched or wet.</li> <li>4. Broken igniter cable.</li> <li>5. Bad piezo igniter.</li> </ol>	<ol style="list-style-type: none"> <li>1. Replace igniter.</li> <li>2. Reconnect igniter cable.</li> <li>3. Free igniter cable if pinched by any metal or tubing. Keep igniter cable dry.</li> <li>4. Replace igniter cable.</li> <li>5. Replace piezo igniter.</li> </ol>
2	When igniter button is pressed in there is a spark at ODS/pilot but no ignition.	<ol style="list-style-type: none"> <li>1. Gas supply is turned off or equipment Shutoff valve is closed.</li> <li>2. Control knob not fully pressed in while pressing igniter button.</li> <li>3. Air in gas lines when installed.</li> <li>4. ODS/pilot is clogged.</li> <li>5. Gas regulator setting is not correct.</li> <li>6. Control knob not in PILOT position.</li> <li>7. Depleted gas supply (propane).</li> </ol>	<ol style="list-style-type: none"> <li>1. Turn on gas supply or open equipment shutoff valve.</li> <li>2. Fully press in control knob while pressing igniter button.</li> <li>3. Continue holding down control knob. Repeat igniting operation until air is removed.</li> <li>4. Clean ODS/pilot (see <i>Care and Maintenance</i>, page 9) or replace ODS/pilot assembly.</li> <li>5. Replace gas regulator.</li> <li>6. Turn control knob to PILOT position.</li> <li>7. Contact local propane/LP gas company.</li> </ol>
3	ODS/pilot lights but flame goes out when control knob is released.	<ol style="list-style-type: none"> <li>1. Control knob is not fully pressed in.</li> <li>2. Control knob is not pressed in long enough.</li> <li>3. Equipment shutoff valve is not fully open.</li> <li>4. Thermocouple connection is loose at control valve.</li> <li>5. Thermocouple damaged.</li> <li>6. Control valve damaged.</li> </ol>	<ol style="list-style-type: none"> <li>1. Press in control knob fully.</li> <li>2. After ODS/pilot lights, keep control knob pressed in 30 seconds.</li> <li>3. Fully open equipment shutoff valve</li> <li>4. Hand tighten until snug, and then tighten 1/4 turn more.</li> <li>5. Replace thermocouple.</li> <li>6. Contact customer service.</li> </ol>
4	Burner(s) does not light after ODS/pilot is lit.	<ol style="list-style-type: none"> <li>1. Burner orifice is clogged.</li> <li>2. Burner orifice diameter is too small.</li> <li>3. Inlet gas pressure is too low.</li> </ol>	<ol style="list-style-type: none"> <li>1. Clean burner orifice (see <i>Care and Maintenance</i>, page 10) or replace burner orifice.</li> <li>2. Contact customer service.</li> <li>3. Contact local gas supplier.</li> </ol>
5	Delayed ignition of burner(s).	<ol style="list-style-type: none"> <li>1. Manifold pressure is too low.</li> <li>2. Burner orifice is clogged.</li> </ol>	<ol style="list-style-type: none"> <li>1. Contact local gas supplier.</li> <li>2. Clean burner (see <i>Care and Maintenance</i>, page 10) or replace burner orifice.</li> </ol>
6	Burner backfiring during combustion.	<ol style="list-style-type: none"> <li>1. Burner orifice is clogged or damaged.</li> <li>2. Burner is damaged.</li> <li>3. Gas regulator is defective.</li> </ol>	<ol style="list-style-type: none"> <li>1. Clean burner orifice (see <i>Care and Maintenance</i>, page 10) or replace.</li> <li>2. Contact customer service.</li> <li>3. Replace gas regulator.</li> </ol>
7	Yellow flame during burner combustion.	<ol style="list-style-type: none"> <li>1. Not enough air.</li> <li>2. Gas regulator is defective.</li> <li>3. Inlet gas pressure is too low.</li> </ol>	<ol style="list-style-type: none"> <li>1. Check burner for dirt and debris. If found, clean burner (see <i>Care and Maintenance</i>, page 10).</li> <li>2. Replace gas regulator.</li> <li>3. Contact local gas supplier.</li> </ol>
8	Slight smoke or odor during initial operation.	<ol style="list-style-type: none"> <li>1. Residues from manufacturing processes.</li> </ol>	<ol style="list-style-type: none"> <li>1. Problem will stop after a few hours of operation.</li> </ol>
9	Heater produces a whistling noise when burner is lit.	<ol style="list-style-type: none"> <li>1. Turning control knob to HI position when burner is cold.</li> <li>2. Air in gas line.</li> <li>3. Air passageways on heater are blocked.</li> <li>4. Dirty or partially clogged burner orifice.</li> </ol>	<ol style="list-style-type: none"> <li>1. Turn control knob to LO position and let warm up for a minute.</li> <li>2. Operate burner until air is removed from line. Have gas line checked by local gas supplier.</li> <li>3. Observe minimum installation clearances (Section 5 page 7).</li> <li>4. Clean burner (see <i>Care and Maintenance</i>, page 10) or replace</li> </ol>

			burner orifice.
10	Heater produces a clicking/ticking noise just after burner is lit or shut off.	1. Metal is expanding while heating or contracting while cooling.	1. This is common with most heaters. if noise is excessive, contact qualified service technician.
11	White powder residue forming within burner box or on adjacent walls or furniture.	1. When heated, the vapors from furniture polish, wax, carpet cleaners, etc., turn into white powder residue.	1. Turn heater off when using furniture polish, wax, carpet cleaner, or similar products.
12	Heater produces unwanted odors.	1. Heater is burning vapors from paint, hair spray, glues, etc. 2. Gas leak. See Checking Gas Supply Statement at the top of page 6. 3. Low fuel supply.	1. Ventilate room. Stop using odor causing products while heater is running. 2. Locate and correct all leaks (see Checking Gas Connections, page 6. 3. Refill supply tank (Propane / LP models).
13	Heater shuts off in use (ODS operates).	1. Not enough fresh air is available. 2. Low line pressure. 3. ODS/pilot is partially clogged.	1. Open window and/or door for ventilation. 2. Contact local gas supplier. 3. Clean ODS/pilot (see Care and Maintenance, page 9).
14	1. Open window and/or door for ventilation. 2. Contact local gas supplier. 3. Clean ODS/pilot (see <i>Care and Maintenance</i> , page 9).	1. Gas leak. See Warning Statement at top of page 6. 2. Control valve is defective.	1. Locate and correct all leaks (see "Checking Gas Connections", page 6). 2. Contact customer service.
15	Gas odor during combustion.	1. Foreign matter between control valve and burner. 2. Gas leak. See Warning Statement at top of page 6.	1. Take apart gas tubing and remove foreign matter. 2. Locate and correct all leaks (see "Checking Gas Connections", page 6).
16	Moisture/condensation noticed on windows.	1. Not enough combustion/ventilation air.	1. Refer to "Air for Combustion and Ventilation" requirements, page 7.

## 9. PARTS LIST (Model: RC9200IT)

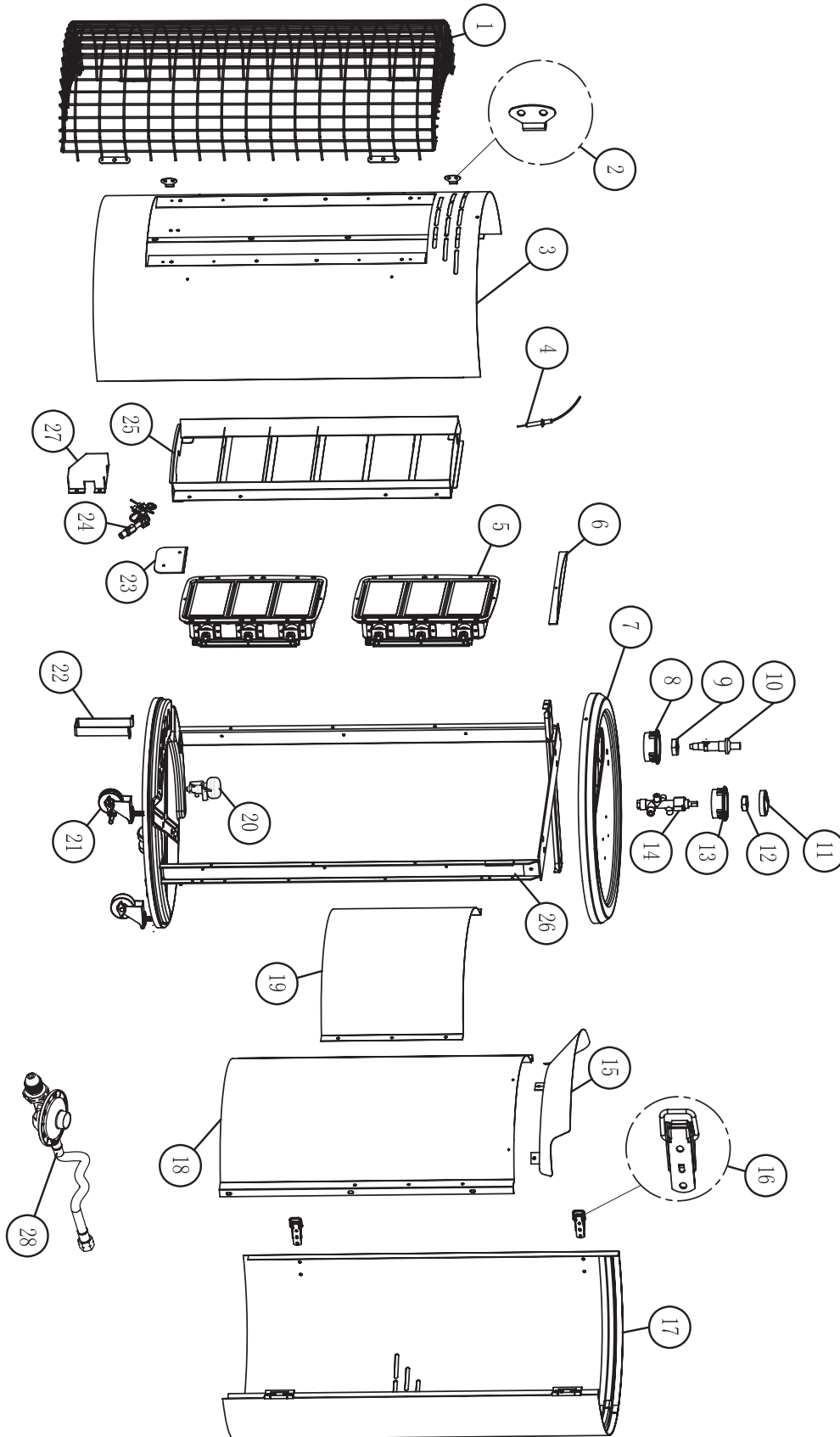

Code	Description
1	Main front protective screen
2	Fastener 1
3	Scatter panel
4	Igniting electrode
5	Burner assembly
6	Burner board
7	Top cover
8	Plastic seat
9	Bolt
10	Ignitor assembly
11	knob
12	Gas pipe Nut
13	Plastic seat
14	Gas safety valve
15	Rear blocked board
16	Fastener
17	Rear cover board
18	Rear insulation board
19	Front insulation board
20	Tip over safety switch
21	Universal wheel
22	Supporting brasket
23	ODS bracket
24	ODS
25	Radiant panel assembly
26	Support plate assembly
27	Wind box
28	Regulator and HOSE

Questions about installation, operation, or troubleshooting should be directed to your installer. If you have additional support questions please call our customer service at 1-877-670-8428 or visit [www.thermablaster.com](http://www.thermablaster.com)

---

**Annual Service Schedule:**

Service Performed	Service Date

Please send in the form below to our office listed below or register online at [www.thermablaster.com](http://www.thermablaster.com)

**Reecon North America, L.L.C.**

**Thermablaster**

**1090 Freeport Road**

**2<sup>nd</sup> Floor**

**Pittsburgh, PA 15238**

**Contact Information**

**Product Information**

Name:	Model:
Phone:	Serial Number:
Email:	Date of Purchase:
Address:	Retailer Purchased From:
City:	Installer Company:
State:	Installer Phone:
Zip:	Zip:

**\*\*All information above is required in order for our company to honor the warranty.\*\***

<p>Comments:</p>       
--